



# Product & Installation Manual

## Wavin Comfia Underfloor Heating



An Orbia business.

# Wavin Comfia Underfloor Heating

## Contents

Underfloor Heating Key .....	2
Why Choose Underfloor Heating? .....	3
The Advantages of Underfloor Heating .....	4
Choosing a System	
The Three Essential Elements .....	5
System Selection Guidance .....	6
Screeded Systems	
Staple System .....	7
Staples and Rail System .....	8
System Plates .....	9
Low Build .....	10
Dry Construction Systems	
Low-Build 18.....	11
Low-Build 25.....	12
Diffuser Plates .....	13 – 14
Manifolds .....	15 – 16
Controls and Thermostats .....	17
Standards and Warranties .....	18
Product Details .....	19 – 23

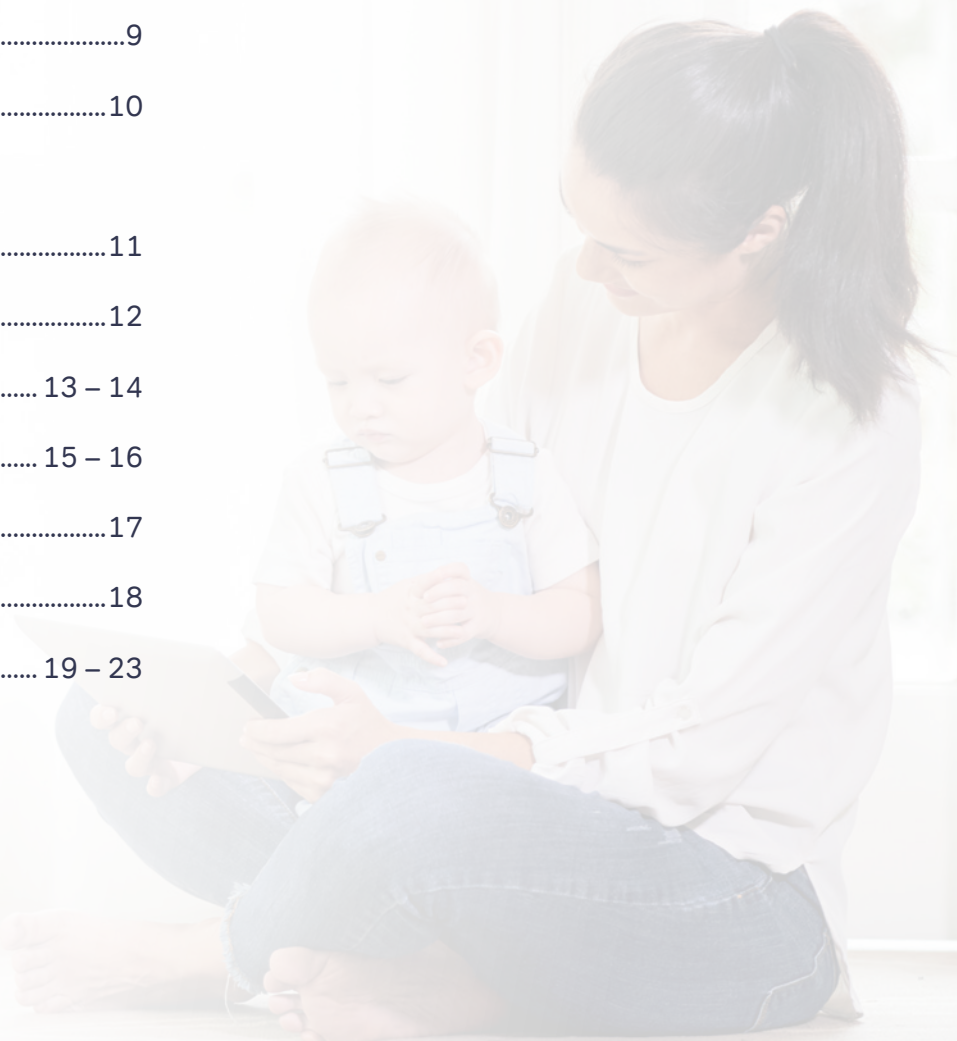

# Wavin Comfia Underfloor Heating

## Pipe

Wavin Pipe



Wavin Pipe



## Layout

Serpent

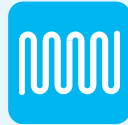

Spiral



## Pipe Spacing

Distance Between Pipe



Infinite Distance



## Diffuser Plates

Single



Double



## Floor Solutions

Staples



Staples & Rails

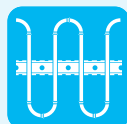

System Plates

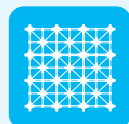

LowBuild Panel



Joist

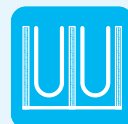

Floating Floor

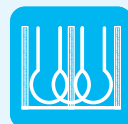

## Floor Base Structure

Wet Screed



Nonstructural Boards



Structural Boards



## Finished Floor

Tile



Carpet



Timber



Vinyl



Laminate



Stone



## Finished Floor Preparation

Tile Adhesive

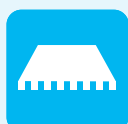

General Adhesive



Underlay



Polythene





# Introduction to Wavin Comfia Underfloor Heating

## Why choose Underfloor Heating?

Underfloor Heating (UFH) using piped warm water is a modern and energy-efficient option for heating homes and other buildings. UFH also delivers comfortable warmth for occupants, as well as other practical benefits. With UFH, the floor is gently heated by piped warm water and the heating energy is emitted from the floor by natural radiation. This heat is absorbed by other surfaces in the room which then also emit warmth.

The result is an all-round, more even warmth than is typically achieved by other space heating techniques. Radiators, for example, use room air to transfer the heat, mostly by convection. This reliance on the convection of air to heat the room results in uneven warmth and higher temperatures at ceiling height compared with floor level. As radiators intrude on the usable space within a room, there is a general desire to keep them as compact as possible. As a consequence of this, the piped water has to be hotter than for UFH in order to achieve the same level of comfort for the occupants.

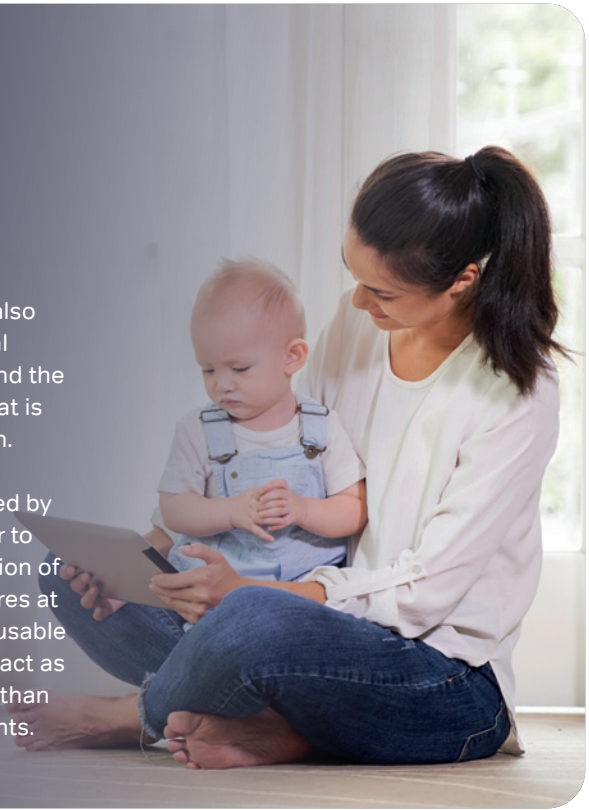

## Underfloor heating offers many benefits to the homeowner

- Lower water temperatures required for UFH mean better energy efficiency with fuel bills up to 20% lower
- More even room temperature ensures all round comfortable warmth
- Silent running – no expansion creaking or water flow noise
- Unhindered room layout - because there are no wall-mounted radiators
- Healthier environment - because less dust is circulating in the air
- Decreased irritants - as the warm floor inhibits the breeding of dust mites and fungi
- Greater safety - because there are no exposed hot surfaces.
- Low maintenance - no radiators to redecorate or renew, or to be 'dropped' to allow room redecoration

## Why Wavin Comfia UFH?

Wavin is the leading plumbing brand in the UK & Ireland, and has been manufacturing professional plumbing systems for over 40 years. Wavin has a range of underfloor heating systems for new and existing floors and offers high quality, proven products. Our systems are easy to install and come with market leading guarantees.

To receive a quotation send your plans and contact details to [ufh.ie@wavin.com](mailto:ufh.ie@wavin.com)

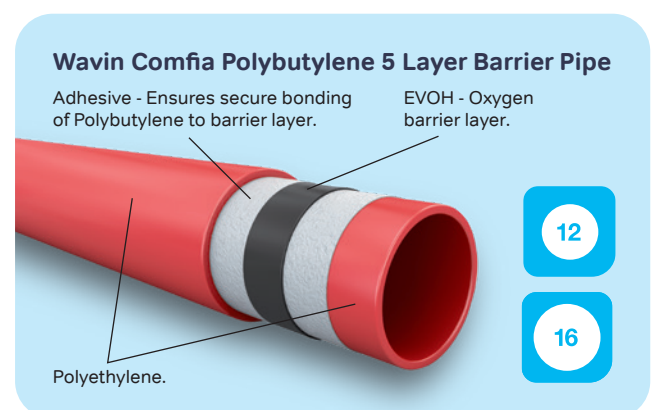



# The advantages of Underfloor Heating

## Radiated heat (UFH)

### Performance Advantages

- A UFH floor only needs heating to 26-28°C (similar to hand temperature) to achieve the required room temperature
- Therefore, UFH requires lower temperatures for heated water:
  - 40-45°C for concrete (screeded) floors
  - 50-60°C for timber floor constructions
- NOTE: radiators typically require water heated to 70-80°C
- Lower water temperatures mean better energy efficiency with fuel bills up to 20% lower (see SOURCE)
- More even room temperature ensures all round comfortable warmth
- Silent running – no expansion creaking or water flow noise

SOURCE: Energy Efficiency Partnership for Homes: Domestic Heating systems ranked by carbon emissions, version 2

### Practical Advantages

- Unhindered room layout
  - because there are no wall-mounted radiators
- Healthier environment
  - because less dust is circulating in the air
- Decreased irritants
  - as the warm floor inhibits the breeding of dust mites and fungi
- Greater safety
  - because there are no exposed hot surfaces
- Low maintenance
  - no radiators to redecorate or renew, or to be 'dropped' to allow room redecoration
- UFH is ideal for connection to renewable energy sources (e.g. heat pumps and geothermal systems)
  - because lower water temperatures are required

## Convected heat

### Typical Comparison with Radiated Heat

- Requires higher temperature at heat source: using water at 45°C with radiators would require the radiator to be three times larger than normal for it to produce the same amount of heat
- Hot air at ceiling level and cooler at floor level, often with associated draughts, so there is uneven warmth
- Significant heat loss through windows, walls and ceilings, representing wasted energy costs
- Dust carried around room in convection currents
- Dry, re-heated air causing a stuffy atmosphere
- Convective air currents (e.g. above radiators) that can stain walls

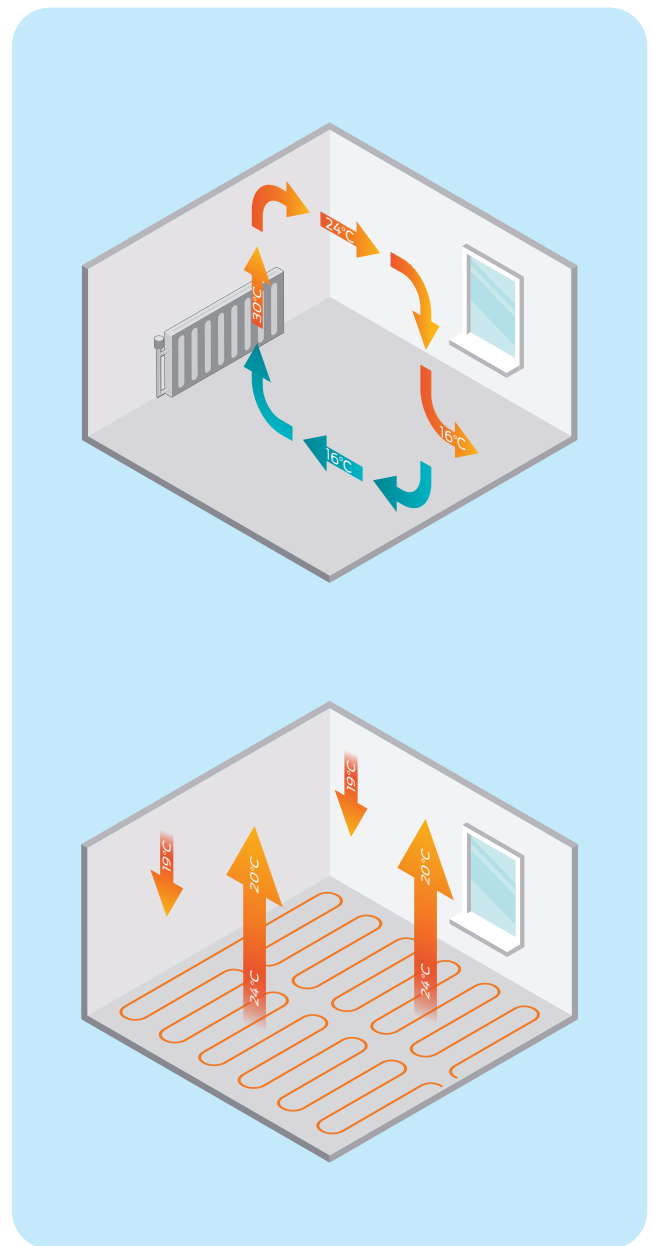

Radiators
Normal HW flow temperature <b>65-70°C</b> - Designed for a boiler capacity of <b>82°C</b>
Underfloor Heating
Normal HW flow temperature to <b>45-50°C</b>
Heat Pump
Normal out put temperature <b>35-45°C</b>

# Choosing a system

## Three essential elements

Our UFH Project Sales team will help you select the products you need, but here is a summary of the basic elements of a system. Plumbed UFH comprises of three key elements that work together to deliver the required heating performance and effect:

1. **Floor products incorporating UFH pipe:** to create the pipework circuits within the floor that will emit heat. Many floor products help to hold the pipe at the correct spacing to ensure even distribution of heat across the floor surface above.
2. **Manifold:** to provide flow and return circulation of warm water at the correct temperature and flow rate to ensure an even, comfortable temperature across the whole floor surface.
3. **Controls:** to monitor water and air temperature and signal the heat source. In effect, the nerve centre of the installed system.

The careful selection of each of these is critical to the efficient operational performance of the entire installation. Let's look at these in more detail.

### Floor products

The choice of floor product is influenced by several factors:

- Whether the floor is being newly constructed or already exists
- Its type of construction: solid/screeded or dry/timber
- The size and shape of the space to be heated
- The type of floor finish that will be installed over the UFH

A solution to suit any combination of these factors, can be found within the Wavin Comfia underfloor heating product range.

### Manifolds

A manifold is required wherever UFH is to be installed to serve two or more plumbed circuits from the boiler (or other primary heat source). When UFH is being connected to a high temperature heat source which also controls hot water or radiators, a mixing unit is connected to the manifold to mix the water to the required temperature for the system.

The Wavin Comfia underfloor heating range includes manifold solutions that can be tailored to each situation. The composite manifold can be sized to serve the exact number of individual UFH circuits up to a maximum of 12 circuits. Single circuit installations which require water temperature control will be connected to their heat source via a mixing unit, but will not require a full manifold. See our video to find out more about what makes our manifold different from others on the market. Search Wavin on YouTube.

### Controls

As with any type of heating, UFH operation requires time and temperature control. Wavin Sentio have several options available, ranging from wired systems to fully networked systems that can be controlled on your mobile device. See page 17 for help in selecting the right solution for you.

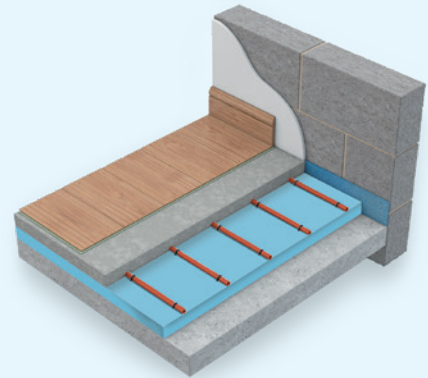
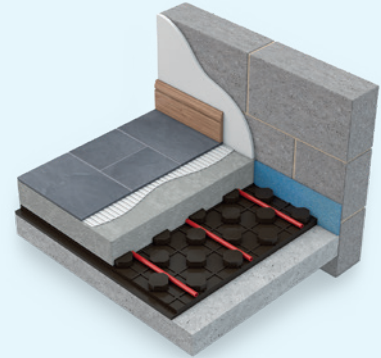

# System selection guidance

## Underfloor Heating

### Advice, Tools and Guidance

Below we offer some general installation advice including layouts and heat outputs.

If you prefer to speak to someone in person, our UFH Project Sales team can offer help and advice. Just give them a call on 01 8020200, or you can email the team at [ufh.ie@wavin.com](mailto:ufh.ie@wavin.com)

### General installation advice:

Recommended pipe centres.

For typical heat output, using 16mm pipe and a boiler, recommended pipe spacing is at 200mm centres. However, for some projects, smaller or greater spacing may be appropriate. For a heat pump system running at lower temperatures, pipes may be laid at 150mm centres in order to maximise outputs.

### Typical pipe layout patterns

There are two typical patterns for laying UFH pipe:



#### Spiral:

Initially at 400mm centres this layout follows the room shape in a spiral to the middle and is then reversed out from middle. This leaves pipe spacing at 200mm centres. This pattern is possible with two Wavin underfloor heating systems – Staples and System Plates. With spiral patterns, close centres can generally be achieved without excessively tight turns.

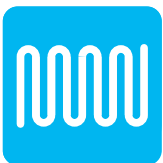

#### Serpentine:

Pipe is laid in parallel runs up and down the room length, with loop turns at each end. Wavin panel products all use the serpentine pattern and it can also be used with staples.

### Some typical room layouts:

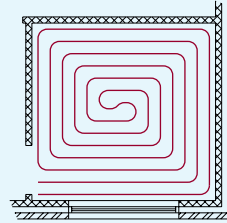

Basic Square

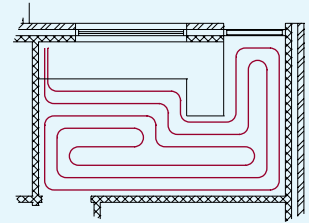

Irregular Shape

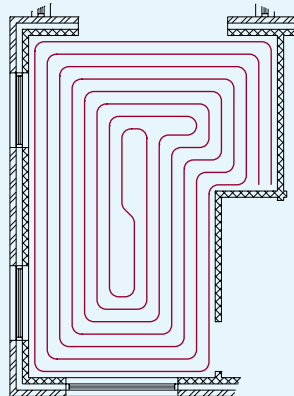

L-Shaped

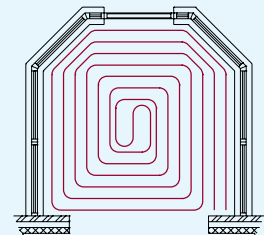

Conservatory

### Typical multi-room layout – Spiral

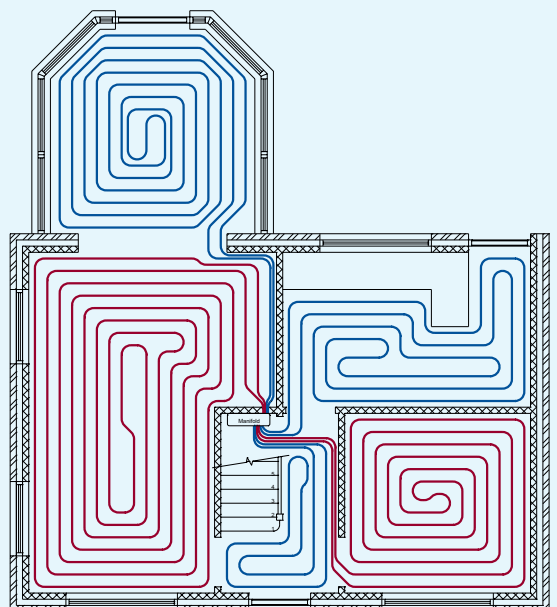





# Staples System

Staple systems offer a cost effective solution for screeded floors. Simply staple the pipe to the insulation panels before the screed is applied.



This option offers flexibility of design and is a great solution for installers who want to minimise cost and are comfortable in spacing and laying out pipework.

## System Construction

1. Selected floor finish
2. Edge expansion foam: with adhesive backing and gaiter to prevent screed ingress under insulation
3. Sand/cement or proprietary screed
4. 12 and 16mm Barrier pipe
5. Staples
6. Polyethene layer
7. Insulation panels: independent choice to suit required thermal/acoustic performance
8. Level solid sub-floor

### Product Overview

Basic system for placing/fixing 12mm and 16mm Barrier pipe.

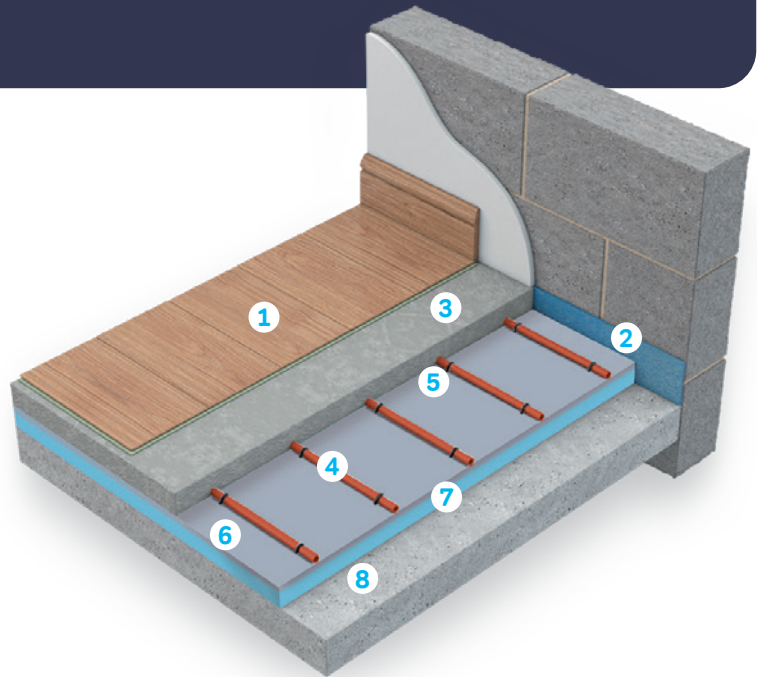

## Features and Benefits

### Product

- Staples to fix pipe in position on rigid insulation
- Lowest material cost

### Design/Installation

- Pipe spacing/layout at installer's discretion  
NOTE: 200mm centres normally offer the best balance of performance and cost for 16mm and 150mm centres for 12mm
- Installer marks top of polythene layer to indicate pipe positioning/spacing
- Full flexibility to set pipe layout and spacing to suit specific project needs
- Independent choice of insulation panels to suit thermal and acoustic properties as required
- Suits irregularly shaped floor areas
- Staple gun available to installer: enables pipe fixing from standing position

### System Performance

- Heat output subject to heat source, pipe spacing and layout consistency

### Transitional Areas

Where pipes need to be supported and secured for run up wall to manifold: Curved Pipe Supports and Clamps are available (see product details section).

### Technical Information

**Base Material:** Nylon 6,6 (Polyamide)

**Staple Length:** 60mm

**Staple Frequency:**  $\approx$  3 Per Metre of Pipe

**Straights:** 500mm Intervals

**Bends:** 3 (Start-Middle-End)

**Supported Pipe Sizes:** 12-16mm

**Pipe Spacing:** Free Form (Typically 200mm)

**Permissible Pipe Deviation:** Specified by EN1264-4

**Vertical:** 5mm

**Horizontal:** +/- 10mm (Off Specified Spacing)





# Staple and Rail System

This system comprises of 1m penta rails fixed directly to the rigid insulation using track rail staples (red). These provide a simple and effective guidance system for ease of installation of the UFH pipe along with 40mm or 60mm staples which are also used to fix the UFH pipe to the rigid insulation. This system ensures the accuracy of the pipe spacing centres.



## System Construction

1. Selected floor finish
2. Edge expansion foam: with adhesive backing and gaiter to prevent screed ingress under insulation
3. Sand/cement or proprietary screed
4. 12 and 16mm Barrier pipe
5. Staples
6. Rails
7. Polythene layer
8. Insulation panels: independent choice to suit required thermal/acoustic performance
9. Level solid sub-floor

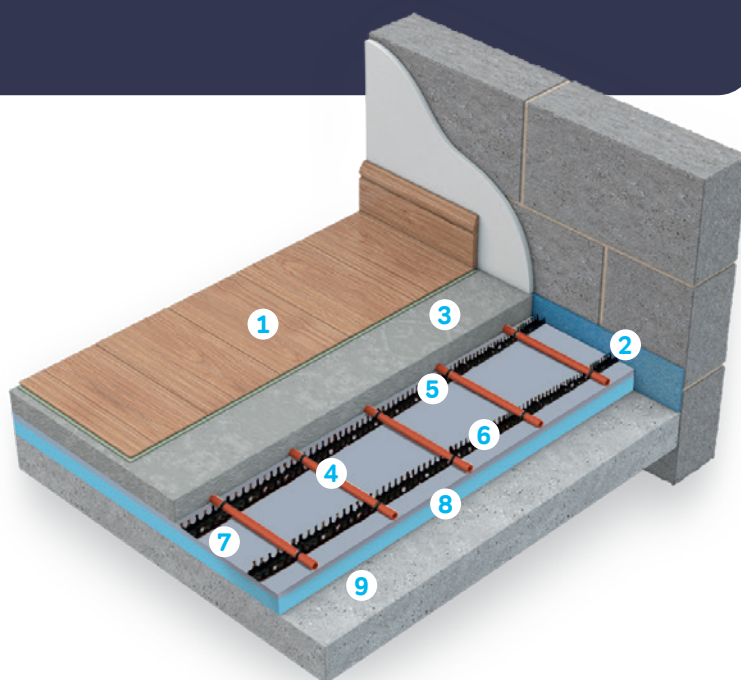

### Product Overview

Basic system for placing/fixing 12mm and 16mm Barrier pipe.

## Features and Benefits

### Product

- Staples and rail to fix pipe in position on rigid insulation
- Economical material cost with flexibility and speed of install

### Design/Installation

- Pipe spacing/layout at installer's discretion  
NOTE: 200mm centres normally offer the best balance of performance and cost for 16mm and 150mm centres for 12mm
- Installer marks top of polythene layer to indicate pipe positioning/spacing
- Each 1m rail has five sections (200mm with 50mm spacings) that can be removed as required to achieve desired length
- Independent choice of insulation panels to suit thermal and acoustic properties as required
- Staple gun available to installer: enables pipe fixing from standing position

### System Performance

- Heat output subject to heat source, pipe spacing and layout consistency

### Transitional Areas

Where pipes need to be supported and secured for run up wall to manifold: Curved Pipe Supports and Clamps are available (see product details section).

### Technical Information

**Staple Length:** 60mm and 40mm

**Staple Frequency:** ≈ 3 Per Metre of Pipe

**Straights:** 500mm Intervals

**Bends:** 3 (Start-Middle-End)

**Rail Distance:** 0.8 to 1m

**Supported Pipe Sizes:** 12-16mm

**Pipe Spacing:** Typically 200mm

**Permissible Pipe Deviation:** Specified by EN1264-4

**Vertical:** 5mm

**Horizontal:** +/- 10mm (Off Specified Spacing)



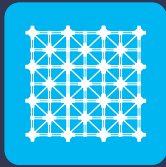

# System Plates

System plates are plastic sheets with pre-formed grips to hold the pipe in position. These are laid on top of insulation panels and hold the pipe in place before the floor is screeded.



This solution allows fast installation and ensures even spacing of the pipe. The sheets can be cut to size with a utility knife and lock together to prevent any screed ingress under the plates. The sheets can support foot traffic, so will protect the pipe if other trades are on site.

## System Construction

1. Selected floor finish
2. Edge expansion foam: with adhesive backing and gaiter to prevent screed ingress under Plates and insulation
3. Sand/cement or proprietary screed
4. 16mm Barrier pipe
5. System Plates
6. Insulation panels: independent choice to suit required thermal/acoustic performance
7. Level solid sub-floor

### Product Overview

Plastic sheets with pre-formed grips to hold 16mm Barrier pipe in position.

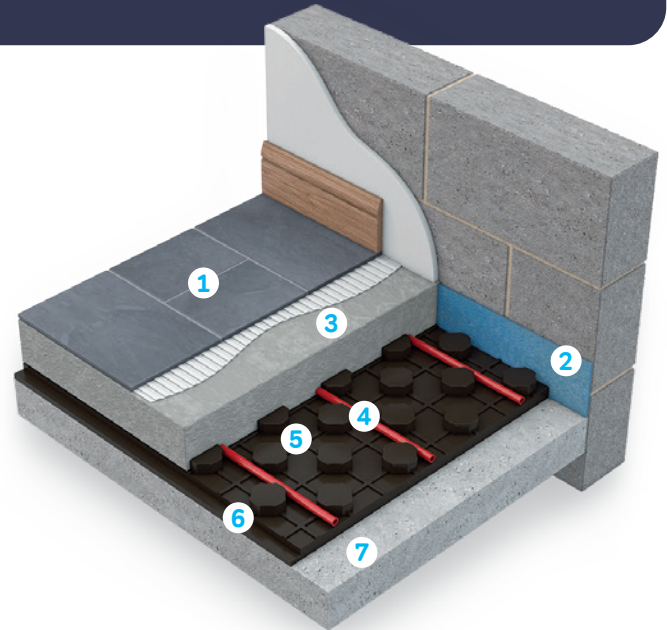

## Features and Benefits

### Product

- Moulded sheets lock together: prevents screed ingress under Plates
- Strong enough to support on-site foot traffic or wheelbarrows before screeding

### Design/Installation

- Sheets easily trimmed to size with utility knife
- Moulded pipe grips designed to make regular spacing easy (in multiples of 75mm)  
NOTE: 225mm centres normally offer the best balance of performance and cost.
  - allow diagonal pipe placement if layout requires
  - protect pipe from foot/wheel traffic before screeding
- No measuring of pipe position needed
- Layout flexibility to suit specific project needs
- Independent choice of insulation panels to suit thermal and acoustic properties as required
- Easy, fast installation  
NOTE: spiral pattern recommended = more even floor surface temperature.

### System Performance

- The supported pipe position improves screed wrap around the pipe reducing voids and increasing performance

### Transitional Areas

Where System Plates are not required or practical and/or where pipes need to be closely placed together (e.g. on approach to manifold): pipes may be anchored to insulation using Staples system. Where pipes need to be supported and secured for run up wall to manifold: Curved Pipe Supports and Clamps are available (see product details section).

### Technical Information

**Base Material:** Recycled Plastic  
**Recycled From:** Styrene-Butadiene Polystyrene  
**Colour:** Near Black  
**Volume of Castellations:** 6.6l/m<sup>2</sup> (excludes pipe)  
**Plate Height:** 22mm  
**Plate Dimensions:** 1275mm x 975mm  
**Effective Area:** 1.08m<sup>2</sup> (1200mm x 900mm)





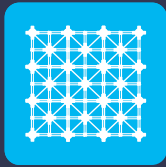

# Low Build System Plates

System plates are plastic sheets with pre-formed grips to hold the pipe in position. These are laid on top of insulation panels and hold the pipe in place before the floor is screeded.



This solution allows fast installation and ensures even spacing of the pipe. The sheets can be cut to size with a utility knife and lock together to prevent any screed ingress under the plates. The sheets can support foot traffic, so will protect the pipe if other trades are on site.

## System Construction

1. Selected floor finish
2. Edge expansion foam: with adhesive backing and gaiter to prevent screed ingress under Plates and insulation
3. Sand/cement or proprietary screed
4. 12mm Barrier pipe
5. System Plates
6. Insulation panels: independent choice to suit required thermal/acoustic performance
7. Level solid sub-floor

### Product Overview

Plastic sheets with pre-formed grips to hold 12mm Barrier pipe in position.

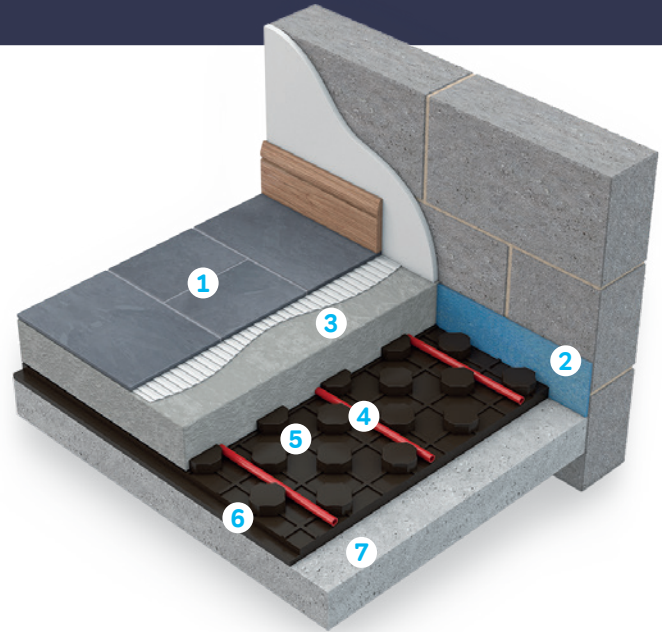

## Features and Benefits

### Product

- Moulded sheets lock together.
- Strong enough to support on-site foot traffic or wheelbarrows before screeding

### Design/Installation

- Sheets easily trimmed to size with utility knife
- Moulded pipe grips designed to make regular spacing easy (in multiples of 50mm)

NOTE: 150mm centres normally offer the best balance of performance and cost.

- allow diagonal pipe placement if layout requires
- protect pipe from foot/wheel traffic before screeding
- No measuring of pipe position needed
- Layout flexibility to suit specific project needs
- Independent choice of insulation panels to suit thermal and acoustic properties as required
- Easy, fast installation

NOTE: spiral pattern recommended = more even floor surface temperature.

### System Performance

- The supported pipe position improves screed wrap around the pipe reducing voids and increasing performance

### Transitional Areas

Where System Plates are not required or practical and/or where pipes need to be closely placed together (e.g. on approach to manifold): pipes may be anchored to insulation using Staples system.

### Technical Information

**Base Material:** Recycled Plastic

**Recycled From:** Styrene-Butadiene Polystyrene

**Colour:** Near Black

**Volume of Castellations:** 6.6l/m<sup>2</sup> (excludes pipe)

**Plate Height:** 16mm

**Plate Dimensions:** 1,005mm x 650mm

**Effective Area:** 0.6m<sup>2</sup>





# Low-Build 18

The Low-Build 18 floor system is used where underfloor heating is to be installed on concrete or timber floors and a dry finish to the floor is required, not a screed topping. The system allows floor finishes, including tiles, to be installed straight to the insulation.

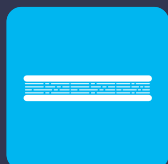

The Low-Build system comprises of pre-channelled polystyrene insulation panels 18mm thick to suit 12mm pipe.

## System Construction

1. Selected floor finish
2. Optional load-bearing plywood layer
3. 12mm UFH pipe: placed into pre-cut channels at 150mm centres
4. Low-Build 18 panel
5. Integral end panel with pre-cut end-return, flow and through-connect channels for pipe
6. Level sub floor

### Product Overview

Ultra-slim insulation panels with channels for 12mm UFH pipe.

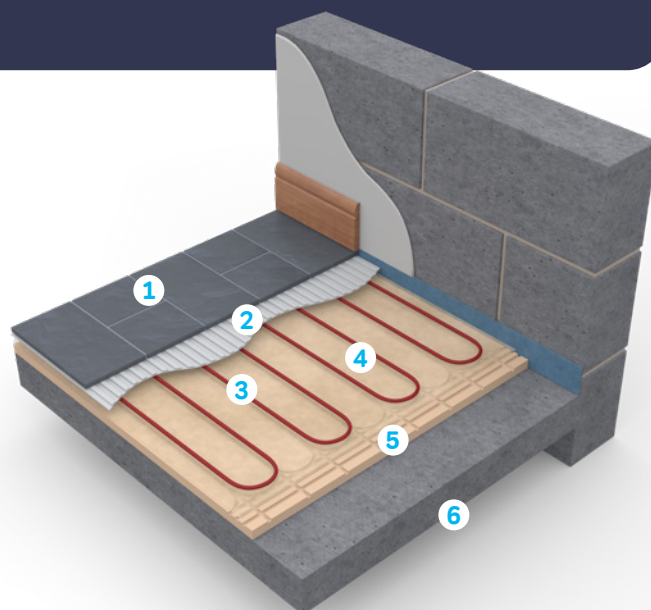

## Features and Benefits

### Product

- Pipe integrated within Low
- Low build up height: 16mm excluding optional load-bearing ply layer
- Comes in 2 x variants, foil-faced or glass fibre with mesh on top

### Design/Installation

- Separate end return panel not required
- Separate diffuser plate not required
- Lightweight panel: easy to cut and install – only one person required\*
- Very low build = minimal rise in floor level = less disruption to doors/skirting
- Pipe in serpentine pattern

### System Performance

- Fixed pipe centres ensure consistent thermal output
- Robust: able to withstand point loading
- Energy-efficient: compared with electric UFH systems, saves up to two-thirds\*\* of running costs

\* Qualified electrician required if mains-connected controls fitted.

\*\* Based on using a SEDBUK A Rated gas boiler, and wet vs electric UFH systems at typical 2010 domestic energy prices.

### Select this system if

- Floor area to be covered is less than 26m<sup>2</sup>
- Area is to be heated as a single zone
- If area is greater than 26m<sup>2</sup>, select this system if:
- Build height is critical
- You want to minimise disruption to existing fitted features including doors and skirting
- For existing joisted/battened floors:
- You do not want to/intend to lift the existing floor deck

### Select alternative system, Low-Build 25 if

- Build height is important but NOT critical
- Existing skirting is to be replaced
- Existing doors are to be replaced, or removed and planed
- Where area is greater than 26m<sup>2</sup> and lowest cost option is sought

### Transitional Areas

For transitional areas, dedicated channel panels are available which insulate the flow and return pipes reducing localised overheating.





# Low-Build 25

The Low-Build 25 Panel floor system is used where underfloor heating is to be installed on concrete or timber floors and a dry finish to the floor is required, not a screed topping. The system allow floor finishes, including tiles, to be installed straight to the insulation.



The Low-Build system comprises of pre-channelled polystyrene insulation panels 25mm thick to suit 16mm pipe.

## System Construction

1. T&G timber or cementitious floor deck
2. 16mm UFH pipe: placed into pre-cut channels at fixed centres
3. Low-Build 25 panel (insulation)
4. Optional aluminium diffuser and polyethylene film
5. Level sub floor

NOTE: 25mm end panel (insulation) required as part of system

### Product Overview

- Slim (25mm depth) insulation panels with pre-fitted heat diffuser and channels for 16mm UFH pipe
- This board will now be foil-faced instead of plates

## Features and Benefits

### Product

- Pipe integrated within insulation thickness: enables full diffuser contact with overlying floor deck
- 25mm insulation thickness
- Supplied with integral PET film

### Design/Installation

- Separate diffuser plate optional
- Easy/fast installation and pipe placement: similar timescale for installing non-heated floating floor
- Insulation and UFH pipe base installed simultaneously: saves labour time/costs
- Panels can be neatly trimmed using hand or powered saws
- Pipe in serpentine pattern
- This board will now be foil-faced instead of plates

### System Performance

- High power output
- Floor structure has low thermal mass = fast response to heat demand changes
- Fixed pipe centres ensure consistent thermal output
- Plastic film prevents floor ticking caused by the diffuser expansion and contraction

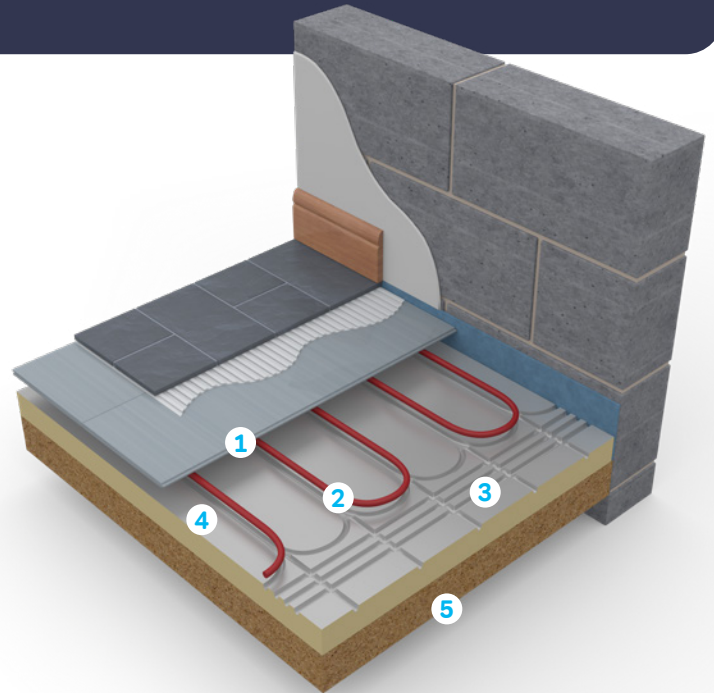

### Select this system if

- Build height is important but NOT critical
- Existing skirting is to be replaced
- Existing doors are to be replaced, or removed and planed
- Where area is greater than 26m<sup>2</sup> and lowest cost option is sought

### Transitional Areas

For transitional areas, dedicated channel panels are available which insulate the flow and return pipes reducing localised overheating. Where pipes need to be supported and secured for run up wall to manifold: Curved Pipe Supports and Clamps are available.







# Diffuser Plates

## Batten floor application



These are metal plates with a channel for 16mm pipe, which are fitted over the insulation layer and disperse the heat from the pipe across the floor. We also supply packs of Diffuser plates.

## System Construction

1. Selected floor finish
2. Diffusion plates
3. 16mm UFH pipe
4. Floor battens
5. Concrete sub floor
6. Solid insulation boards
7. Leveling blocks

### Product Overview

Metal plates with a channel for 16mm pipe which are fitted over the insulation layer.

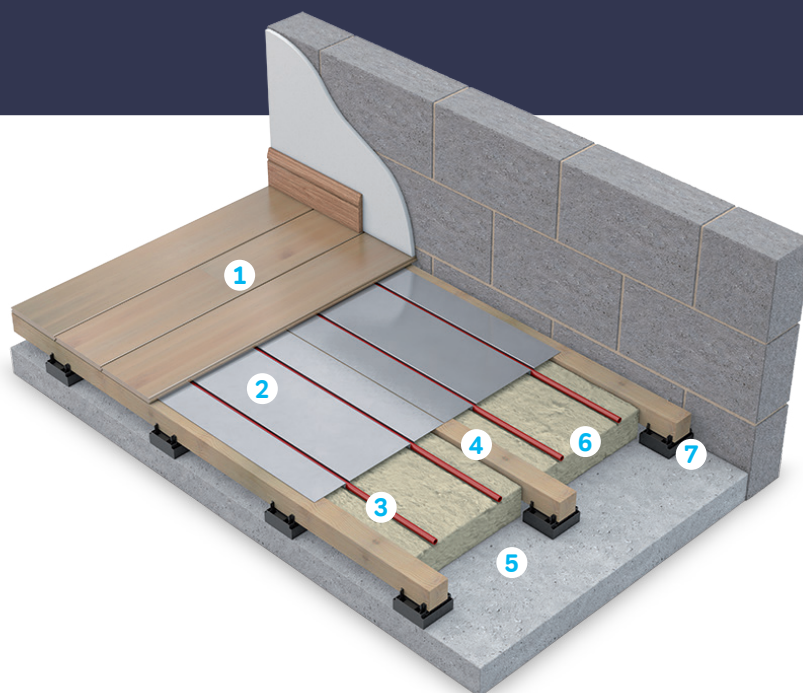

## Application

- The diffusion plate system is an option available when adjustable height floor battens are utilised.
- Rigid floor insulation should be installed between the battens by the flooring contractor to the required depth.
- Metal diffuser plates are pre-formed with inset pipe grooves and are fixed to the top of the floor battens.
- Wavin pipework is slotted into the plate's pipe grooves and circuited throughout the heated floor.
- If this system is used on ground floors or floors with commercial applications below, the thermal value of the insulation used must be suitable for the floor to meet the requirements of part L Building regulations.
- The underfloor pipework is connected to the Wavin manifold, filled with water, and pressure tested.
- As soon as practical after the installation is completed, the flooring should be laid over the system to the required depth. The system must remain under pressure during this process.

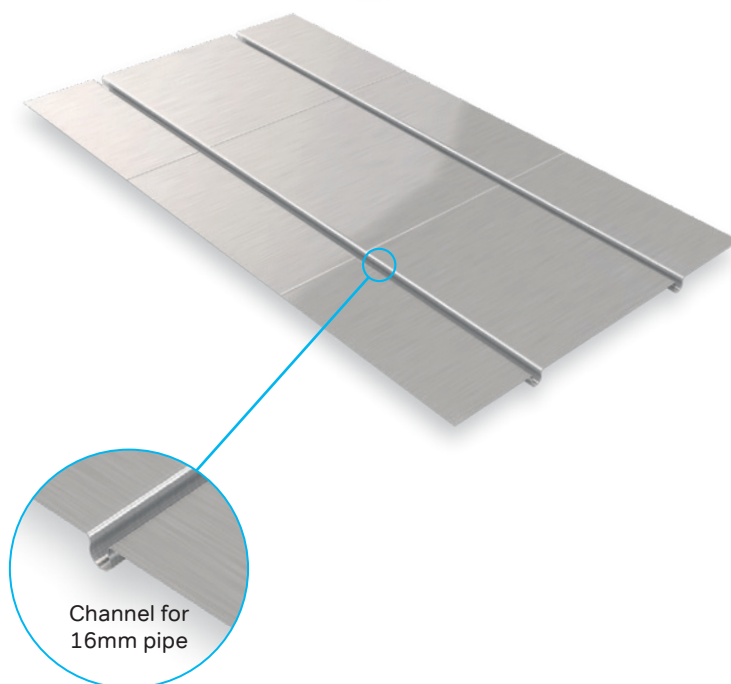



# Diffuser Plates

## Joisted floor application



These are metal plates with a channel for 16mm pipe, which are fitted over the insulation layer and disperse the heat from the pipe across the floor. We also supply packs of Diffuser plates.

## System Construction

1. Selected floor finish
2. Diffusion plates
3. 16mm UFH pipe
4. Floor joist
5. Solid insulation panel
6. Structural floor

### Product Overview

Metal plates with a channel for 16mm pipe which are fitted over the insulation layer.

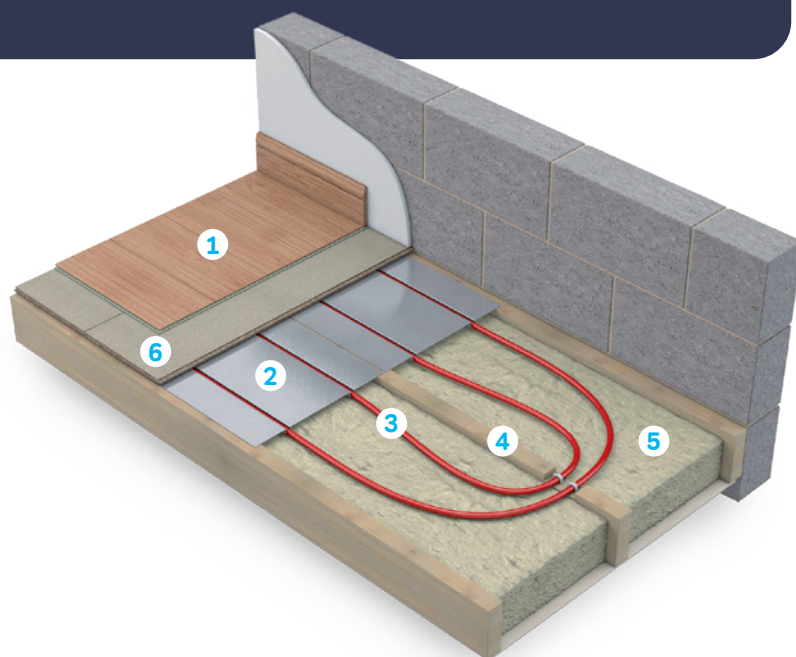

## Application

- The joisted diffusion plate system comprises of aluminium diffusion plate fixing system with compressible or rigid insulation between the floor joists
- The metal diffuser plates are pre-formed with inset pipe grooves and are fixed to the top of the floor battens
- Wavin pipework is slotted into the plate's pipe grooves and circuited throughout the heated floor
- Where this system is used on ground floors or floors with commercial applications below, the thermal value of the insulation used must be suitable for the floor to meet the requirements of part L Building regulations
- The diffusion plates may bow upon installation of the pipe work; this will have no detrimental effect to the output of the system
- The underfloor pipework is connected to the Wavin manifold, filled with water, and pressure tested
- As soon as practical after the installation is completed, the flooring should be laid over the system to the required depth. The system must remain under pressure during this process

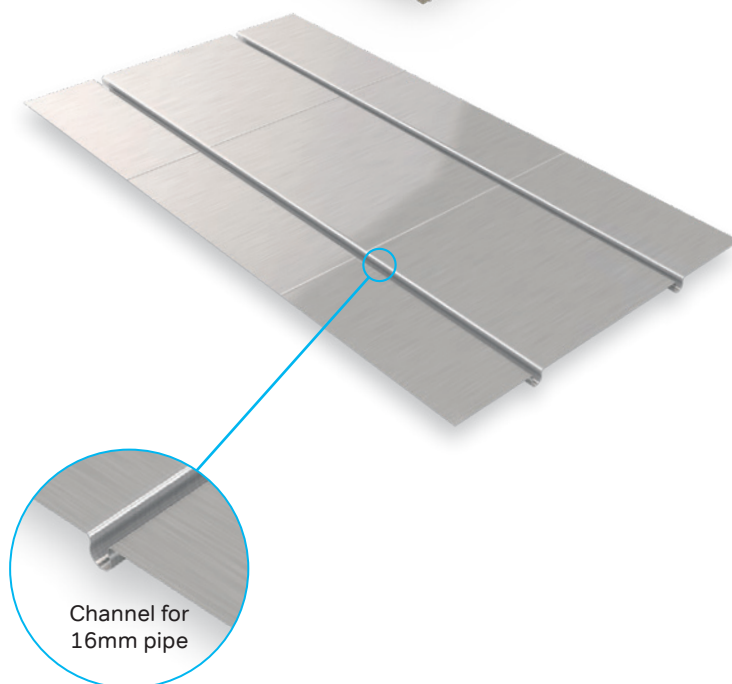



# Wavin Comfia Composite Manifold

The unique Wavin Composite Manifold is easy to install and gives you unrivalled flexibility.

## Main Features

- Lightweight: simple to assemble and easy to install
- No special tools required
- Can be assembled in either left or right configuration Ports can be assembled facing up or down as required to supply rooms above or below the manifold location
- Easily extendable: additional circuits can be added at any time
- Unique 'Memory Ring' enables individual circuit isolation, with quick and simple balancing without tools
- A single circuit can be isolated and balanced without unbalancing the system
- BBA certified for a 25 year service life

## Single Circuit Controls

A cost effective way to control a single room or smaller project is to use a single circuit control. This incorporates a standard circulator with an advanced mixer valve, to ensure the water flows at the correct temperature around the system. A single control is suitable for circuits smaller than 100m<sup>2</sup> with a heated floor area of 20m<sup>2</sup> or less. Simply use an adaptor and spigot elbow to connect the pipe circuit to the unit. For rooms of up to 24m<sup>2</sup> you can split the coil and use a tee fitting to create 2 circuits.



## Manifold Design

1. Automatic Air Vent (AVV)
2. Flow Temperature Gauge
3. Flow Rate Indicator
4. Wall Mounting Bracket
5. Manual Head
6. Pipe Connectors 16mm
7. Combined Pressure and Temperature Gauge
8. Fill and Drain Valve
9. Connection for Isolating Valves

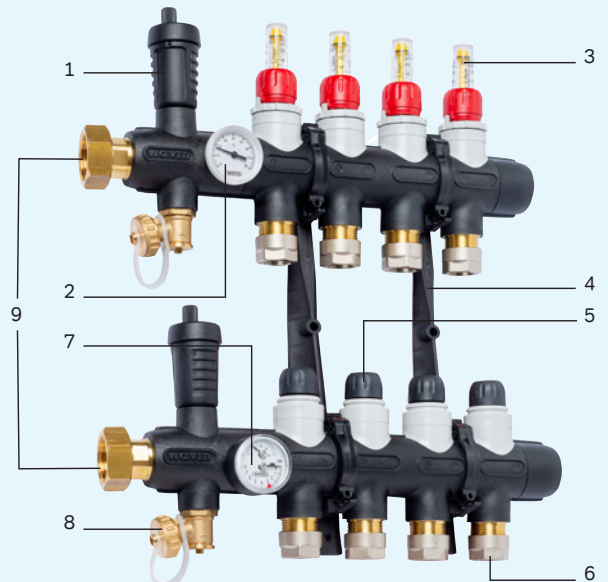

Manifold Type	Height	Depth	Width in mm / No. of Ports														
			1	2	3	4	5	6	7	8	9	10	11	12	13	14	15
Exc Control Pack	390	120	260	310	360	410	460	510	560	610	660	710	760	810	860	910	960
Inc Control Pack	430	160	400	450	500	550	600	650	700	750	800	850	900	950	1000	1050	1100



# Stainless Steel Blending Manifold

The Stainless Steel Blending Manifolds are used for distributing and regulating the volume of flow in low temperature floor heating or cooling systems.

This Manifold blends and reduces the water temperature from the heat source to the correct operating temperature for the underfloor heating. The pump manifold utilises a Grundfos UPM3. The maximum permissible continuous operating pressure is 5 bar at 80°C. The maximum permissible test pressure is 10 bar at 20°C during the pressure test.

The manifold is complete, for each circuit, with shut-off and control valves that can be motorized on the return and 0-6 lit/min flow rate gauges on the flow, both with 3/4" eurocone connections. Including fill/drain tap, manual air vent valves, and mounting brackets. The manifold is made of stainless steel, and for each circuit it is complete with control and shut-off valves that can be motorized on the return, and 0-6 lit/min flow rate gauges on the flow.

The manifold is complete with fill / drain taps, and manual air vent valves installed on the flow and the return, as well as mounting brackets.

The sealed actuator units also allow safe operation when ports are serving circuits above the manifold. The manifold has 1" flow and return primary connections which can be handed to suit specific requirements. The manifold can be used to manage up to a maximum of 12 radiant circuits, and complete with:

- 0-6 lit/min flow rate gauge
- Shut-off valve that can be motorized, on the return
- Fill and drain taps
- Manual vent valves

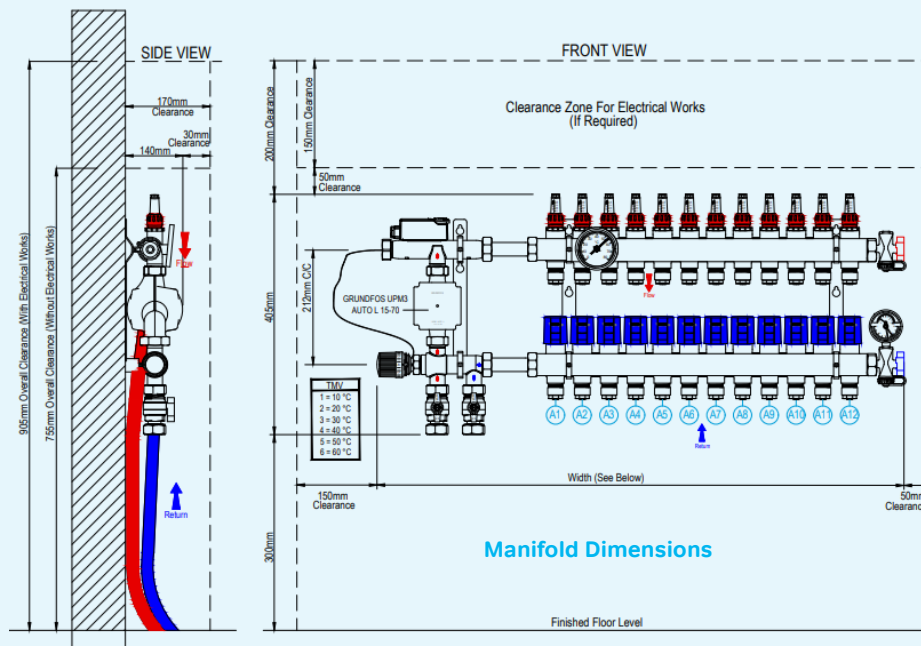

Manifold Type Stainless Steel	STAINLESS STEEL BLENDING MANIFOLD DIMENSIONS											
Height 405mm	<b>No. of Ports</b>	2	3	4	5	6	7	8	9	10	11	12
Depth 140mm	<b>Width in mm</b>	500	550	600	650	700	750	800	850	900	950	1000





# Wavin Sentio UFH Controls and Thermostats

## Which is the right control system?

Every project has different requirements so Wavin underfloor heating controls have a choice of controls to choose from. Below is a summary which will help you select the right system.



Sentio Smart Controls		24v Control System
<p><b>1 CONNECT</b> The thermostat</p> <p><b>2 SET</b> Desired temperature</p> <p><b>3 GO</b> With Sentio</p> 		
Max no. of zones per control unit	8 (up to 16 with optional extension unit)	up to 16
Wiring options	Wired or Wireless	Wired or Wireless
Program options	Programmable – 7 day time and temperature	Non programmable and programmable
App control	Yes	No
Benefits	Control centrally either by the touchpad or via any remote device e.g. phone, tablet, PC. BMS integration capabilities via MODBUS.	Localised cost effective control system

# Underfloor heating Standards and Warranties

## Indoor Climate Solutions Product Warranties

Provided that their installation is in line with our published advice, Wavin products used within Wavin systems are covered as follows:

- Wavin Polybutylene pipe when used in underfloor heating applications – 100 year warranty
- Manifolds and manifold accessories – 2 years
- Controls – 2 years
- Flooring solutions – 1 year

See Wavin terms and conditions for further information.

## Quality and Environmental Management

All Wavin products are manufactured under exacting Quality and Environmental management systems:



- BS EN ISO 9001:2008.
- EN ISO 14001:2004 Certificate No.1473.



# Product Details

## Underfloor Heating

### UFH Pipe Coils

Pipes	Description	Nom dia mm	Cat N°
	<b>PB Barrier Pipe Coils</b>		
	500m x 16mm	16	3092831
	200m x 16mm	16	3092780
	150m x 16mm	16	3092800
	120m x 16mm	16	3092736
	100m x 16mm	16	3092737
	80m x 16mm	16	3092722
	50m x 16mm	16	3092785
	100m x 12mm – Use with low-build	12	3092806
	80m x 12mm – Use with low-build	12	3092779
50m x 12mm – Use with low-build	12	3092810	
	<b>Multi layer Alu-Pert Pipe</b>		
	500m x 16mm 200m x 16mm	16 16	3017597 3017595

### UFH – Floor Fixings and Accessories

Staples and Gun	Description	Nom dia mm	Cat N°
	<b>Staples 60mm</b> for 16mm pipe	16	3092773
	<b>Staple Gun</b> for 40mm & 60mm staples		3092802
Staples and Rail System	Description	Nom dia mm	Cat N°
	<b>Clip Rail L</b> 1m		3091681
	<b>Clip Rail Staple</b>		4038834
System Plate	Description	Nom dia mm	Cat N°
	<b>25mm System Plate</b> for 16mm pipe (1275 x 975mm)	16	3092798
	<b>Low Build System Plate</b> for 12mm pipe (1050 x 650mm)	12	3092744
	<b>System Plate Tack Fastener</b>		3092829



# Product Details

## Underfloor Heating

Low-Build Panel System	Description	Nom dia mm	Cat N°
	<b>Low-Build 25 Panel</b> for 16mm pipe	16	3092754
	<b>Low-Build 18 Panel</b> for 12mm pipe, foil-faced for 12mm pipe, glass-fibre mesh	12 12	3092763 3092818
	<b>Low-Build Panel Adhesive</b> 14kg		3093199
Diffuser Plate	Description	Nom dia mm	Cat N°
	<b>Double Diffuser Plate</b> for 16mm pipe	16	3092777
	<b>Triple Diffuser Plate</b> for 16mm pipe	16	3092783
Edge Expansion Foam	Description	Nom dia mm	Cat N°
	<b>Edge Expansion Foam</b> 25m x 150mm		3092825
Bend Former	Description	Nom dia mm	Cat N°
	<b>Cold Forming Bend</b> for 16mm pipe	16	3033959
	<b>Cold Forming Bend</b> for 12mm pipe	12	3092758



## UFH – Manifolds – Composite

Control Pack	Description	Cat N°
	Composite Manifold Control Pack	3092823
Starter Pack	Description	Cat N°
	Composite Manifold Starter Pack	3092749
Single Port Module	Description	Cat N°
	Composite Manifold 1-Port Module Flow module with indicator	3092733
	Composite Manifold 1-Port Module Return module	3092751
Three Port Module	Description	Cat N°
	Composite Manifold 3-Port Module Flow module with indicator	3092778
	Composite Manifold 3-Port Module Return module	3092803
Euroconus Adaptor	Description	Cat N°
	Manifold Euroconus Adaptor for 16mm pipe for 12mm pipe	4060502 3092797
Isolation Valves	Description	Cat N°
	Composite Manifold 22mm Isolation Valves Pair	3092788
Flow Watch Thermostat	Description	Cat N°
	Composite Manifold Flow Watch Thermostat	3092811

## UFH – Manifolds – Stainless Steel

Stainless Steel Manifold	Description	Cat N°
	<b>Stainless Steel Manifold</b>	
	2 Port	3092735
	3 Port	3092741
	4 Port	3092734
	5 Port	3092759
	6 Port	3092762
	7 Port	3092727
	8 Port	3092732
	9 Port	3092723
	10 Port	3092731
	11 Port	3092725
	12 Port	3092721
S/S Manifold Ancillaries	Description	Cat N°
	Stainless Steel Single Way Kit	3092766
	Stainless Steel Isolating Valves 1"	3092757
	Thermometer for Ball Valves	3092730
	Thermometer with Spring	3092729
	Auto Airvent with Non Return	3092726
	Coupling 1" Female-Female	3092719

# Product Details

## Underfloor Heating

### UFH – Sentio Network Controls

Sentio Control Centre	Description	Cat N°
	<b>8 Zone Control Centre</b>	4063796
	<b>8 Way Extension Unit</b> for use with 4063796	4063800
	<b>Sentio VFR Extension Unit</b>	4063801
	<b>Sentio Thermostats</b> Wired Wireless Wireless with Infra-Red Floor Sensor	3077000 3077001 3077004
	<b>Sentio Thermostat Frame</b>	4063803
	<b>Sentio Sensors</b> Wired Wireless	3077002 3077003
	<b>Sentio Smart Radiator Thermostat</b> including M28 and M30 adaptors	4063805
	<b>Sentio Actuator Adaptor</b>	4054939

Sentio Control Centre Cont.	Description	Cat N°
	<b>Sentio Strap On Pipe Sensor</b>	4064150
	<b>Sentio Wired Outdoor Sensor</b>	4063806
	<b>LCD Touch Screen</b>	4063802
	<b>Sentio USB Converter Cable</b>	4064828

### UFH – 24v Controls

UFH 24V Controls	Description	Cat N°
	<b>16 Zone Control Centre (24V)</b>	3071174
	<b>Wired Programme Thermostat (24V)</b>	3071169
	<b>Wireless Programme Thermostat (24V)</b>	3071171
	<b>Remote/Floor Sensor Probe</b>	3092821
	<b>Sensor Probe Cover</b>	3092739

## UFH – Actuators

Actuator	Description	Cat N°
	<b>24v Actuator</b> Compatible with UFH Sentio and 24V controls	3092817
	<b>230v Actuator</b> Compatible with 230V UFH controls	3092804
	<b>Actuator Adaptor</b>	3092728

## Contact Information

To discuss your project  
 email: [ufh.ie@wavin.com](mailto:ufh.ie@wavin.com)  
 Tel: +353 (0) 1802 0200

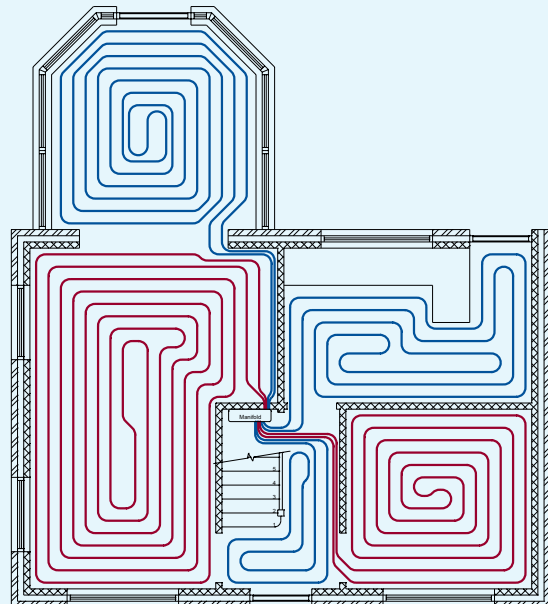





Wavin is part of Orbia, a community of companies working together to tackle some of the world's most complex challenges. We are bound by a common purpose: To Advance Life Around the World.

Orbia's Building and Infrastructure business Wavin is an innovative solutions provider for the global building and infrastructure industry. Backed by more than 60 years of product development experience, Wavin is advancing life around the world by building healthy, sustainable environments for global citizens. Whether it's to improve the distribution of clean drinking water, to make sanitation accessible for everyone, to create climate resilient cities, or to design comfortable living spaces, Wavin collaborates with municipal leaders, engineers, contractors, and installers to help future-proof communities, buildings and homes. Wavin has 12,000+ employees around 65 production sites worldwide, serving over 80 countries through a global sales and distribution network.

Wavin Ireland Ltd | Registered Office | Balbriggan | Co Dublin | K32 K840  
Tel. 01 8020200 | [www.wavin.ie](http://www.wavin.ie) | [ufh.ie@wavin.com](mailto:ufh.ie@wavin.com)

© 2024 Wavin. Wavin reserves the right to make alterations without prior notice. Due to continuous product development, changes in technical specifications may change. Installation must comply with the installation instructions.